

INSTALLATION INSTRUCTION ODEON LIGHT ART. 4044/1

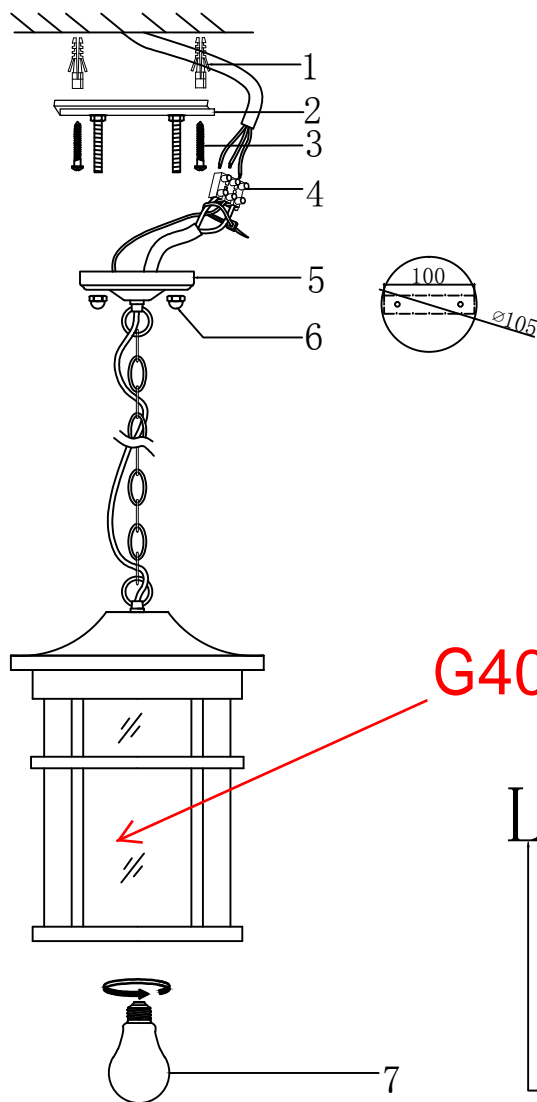

Outdoor pendant lamp

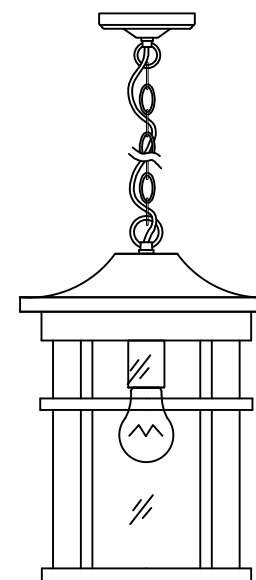

1 x E27(100w)

